



## Instructions for Pro Magnum Feeder Kit

THANK YOU for your purchase of the Pro Magnum Feeder Kit. Please read this sheet before operating the unit. If you should have any questions about this product or any other Moultrie product, please contact us using the information on the back of this sheet. To help us to better serve you and to activate your 2-year warranty, please submit your Warranty information online at <http://www.moultriefeeders.com/warranty>

### I DRILLING YOUR DRUM/BARREL/BUCKET

**NOTE: If you purchased a Moultrie barrel, go to step II**

*Pro Magnum will mount to the bottom of any drum or bucket*

**CAUTION: WEAR EYE PROTECTION**

- 1 Turn drum over, measure and mark the center of the bottom.
- 2 Center the provided template on the bottom of the drum and secure with tape. Drill three 5/16" Feeder Leg Holes.
- 3 Using a Hole Saw, drill a 2.25" hole in the center of the bottom of your drum.

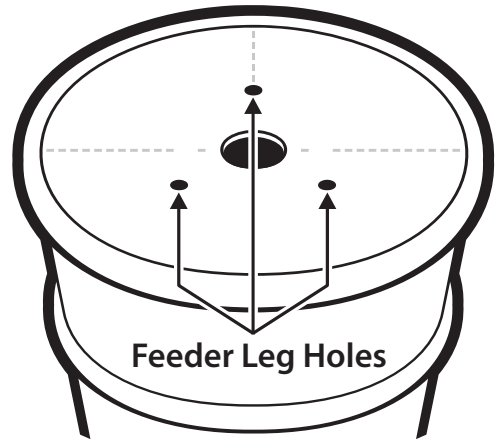

### II MOUNTING THE FEEDER

- 1 From the inside of the drum, slide the three provided Bolts through the holes on the bottom and into the provided Flat Nuts. From the inside, using a Phillips head screwdriver, turn the Bolt clockwise until the Flat Nut is tight against the bottom.

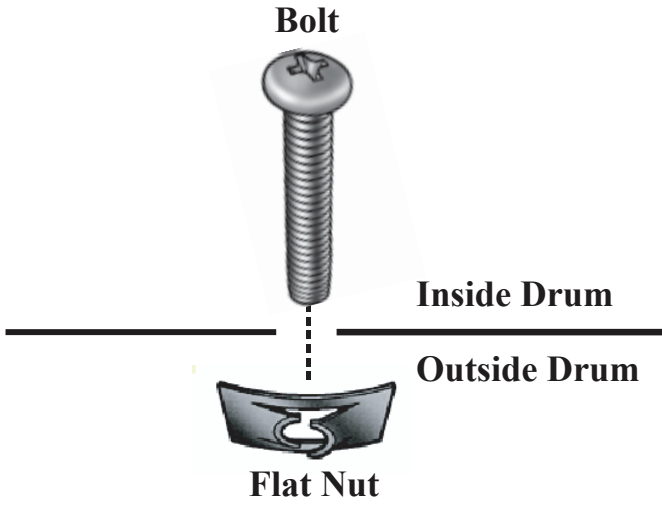
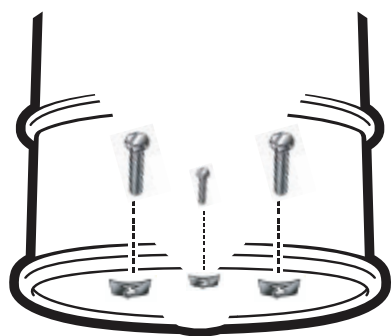

- 2 Slide feeder over three Bolts that are sticking firmly through the bottom of the drum. Attach Feeder Kit to the Drum using the three provided Wing-Nuts.

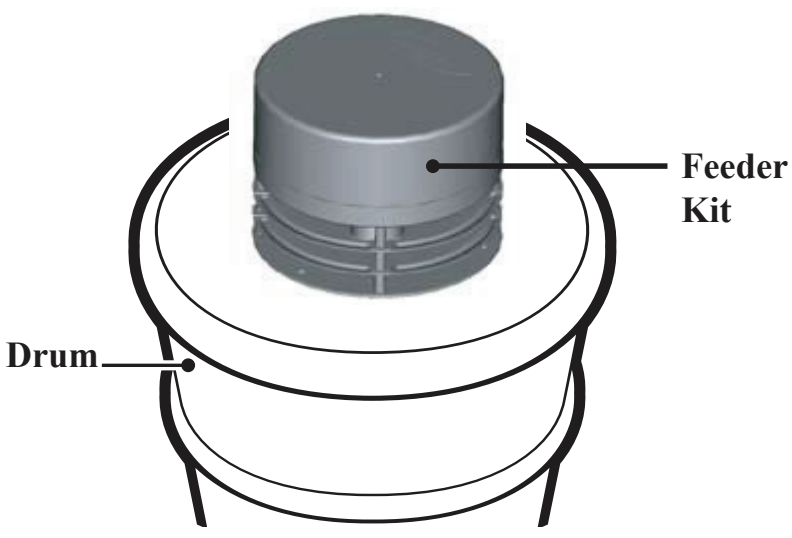

# III INSTALLING BATTERY



**CAUTION: WEAR EYE PROTECTION**

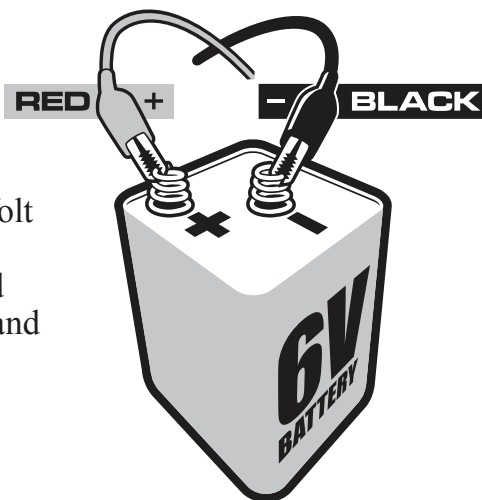

Remove bottom and install one or two 6-Volt Alkaline (ex. Energizer™) or Moultrie rechargeable batteries by attaching the Red Alligator Clip to the positive terminal (+) and the Black Alligator Clip to the negative (-) terminal.

# IV CONFIGURING AND TESTING FEEDER

**1 INSTALL BATTERY:** Open Control Box door and install a 6-Volt Alkaline (ex. Energizer™) or Moultrie rechargeable battery (MFH-SRB6) by attaching the Red Alligator Clip to the positive terminal (+) and the Black Alligator Clip to the negative (-) terminal.

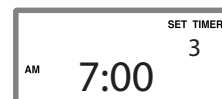

**2 SET TIME OF DAY:** Press the UP or DOWN button until the correct time of day appears. Press and release button to single-step through the minutes or hold down to advance quickly.



**3 SET FEED TIMES:** Press the SET button until the correct Timer Number appears in the upper right hand corner as shown. Press the UP or DOWN button to set the Feed Time.  
**Note: Factory settings are 7am and 6pm.**

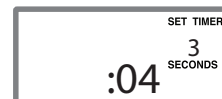

**SET RUN DURATION:** Press the SET button again to set the RUN-TIME SECONDS which can range from zero to twenty seconds. Adjust RUN-TIME SECONDS using the chart below. Set the RUN-TIME SECONDS to zero to disable the specific timer.  
**Note: Factory setting is 4 seconds.**

RUN TIME (sec.)	1	2	3	4	5	6	7	8	9	10	11	12	13	14	15	16	17	18	19	20
Approx. Feed Dispensed (lbs.)	.38	.62	.88	1.0	1.2	1.5	1.7	1.9	2.2	2.4	2.6	2.8	3.0	3.3	3.5	3.7	4.0	4.2	4.4	4.6

**4 SET FEED LEVEL:** Your Feeder Timer is equipped with a Feed Level Estimator. Press the SET button until "SET FEED" appears. Enter the amount of feed (lbs.) added to Hopper. The timer will automatically estimate the amount of feed remaining in lbs. and days after auto-scroll begins.

**Note: The above estimates are based on using deer corn. Feed type, size and density will affect calculations.**

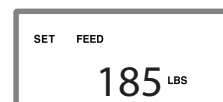

**5 TEST FEEDER:** PRESS AND HOLD the SET button while the RUN-TIME SECONDS are displayed. Release the button and get away from the feeder when the message "TESTING GET AWAY" appears on the display.

## Helpful Tips:

- For extended battery life, the Moultrie Deluxe Solar Panel (MFH-DSP) or Feeder PowerPanel (MFA-12602) can be added using the External Power Port.
- For added security against pests, the Moultrie Varmint Guard (MFH-VG) can be added.
- Replacement parts can be purchased from Moultrie's customer service line at the number below.
- Your feeder has a 2-year warranty against manufacturing defects from point of purchase. Visit [www.moultriefeeders.com/warranty](http://www.moultriefeeders.com/warranty) for more information.

NOTE: This equipment has been tested and found to comply with the limits of Part 15 of the FCC Rules. These limits are designed to provide reasonable protection against harmful interference in a residential installation. This equipment generates, uses and can radiate radio frequency energy and, if not installed and used in accordance with the instructions, may cause harmful interference to radio communications. However, there is no guarantee that interference will not occur in a particular installation. If this equipment does cause harmful interference to radio or television reception, which can be determined by turning the equipment off and on, the user is encouraged to try to correct the interference by one or more of the following measures:

- Reorient or relocate the receiving antenna.
- Increase the separation between the equipment and receiver.
- Connect the equipment into an outlet on a circuit different from that to which the receiver is connected.
- Consult the dealer or an experienced radio/TV technician for help.



Our Service Department will gladly answer any questions you have. Call **800-653-3334**, Monday - Friday, 8:00 AM to 5:00 PM CST.

[www.moultriefeeders.com](http://www.moultriefeeders.com)